

1591XXFS Enclosure

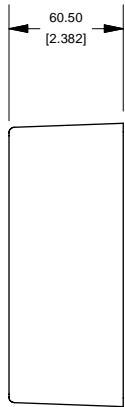

SIDE VIEW OF BOX

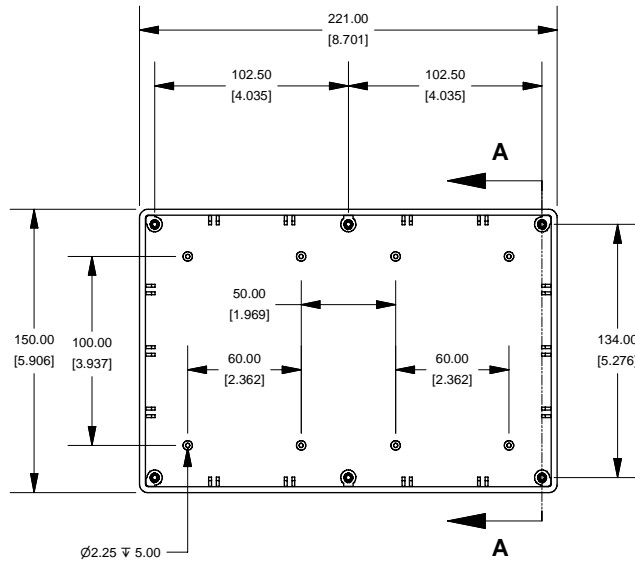

TOP VIEW OF BOX

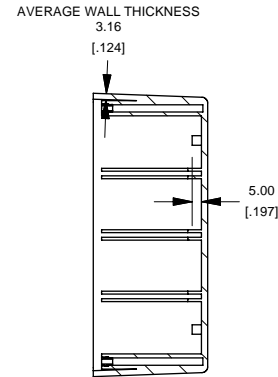

SECTION A-A

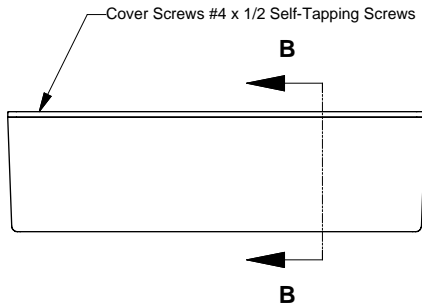
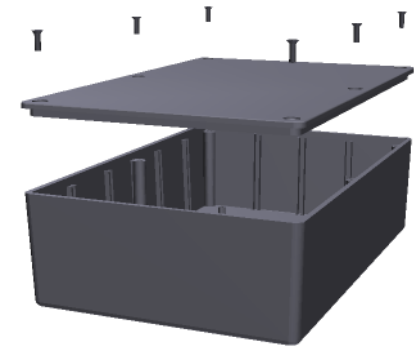

SECTION B-B

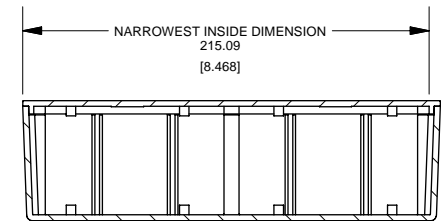
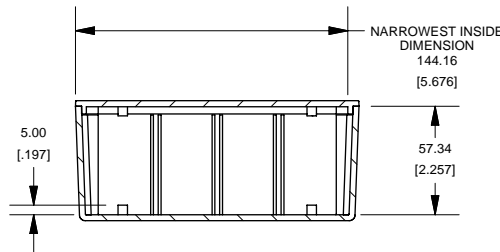

SECTION C-C

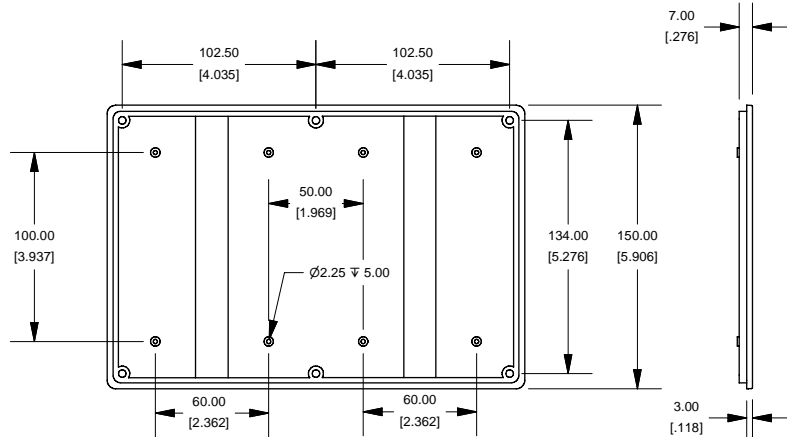

BOTTOM VIEW OF LID

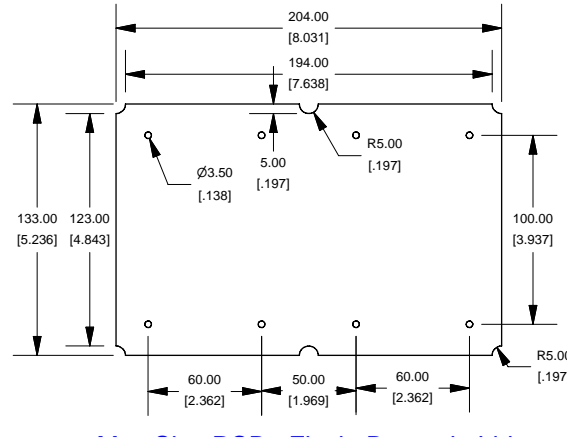

SIDE VIEW OF LID

Max Size PCB. Fits in Box or in Lid.
Not supplied with Enclosure

Note:

Enclosures available modified, Milling, Drilling, Silk Screening.
Solid models of this enclosure available in STEP or IGES.
Contact Factory mjm@hammondmfg.com

NOTE	
Enclosure molded from GPABS UL-94HB plastic	
Other materials / colours available. Consult factory.	

1591XXFS	
1591XXFS Enclosure	
Black - RAL 7011	1591XXFSBK
ACCESSORIES	
Black Cover Screws	1591TS100BK
PCB Screws	1593ATS50 (pkg 50)
[#4 x 1/4" self-tapping (6.4mm)]	1593ATS100 (pkg 100)

