

VERONICA-SQ-MINI-RS

~17° spot beam

TECHNICAL SPECIFICATIONS:

Dimensions	13.9+13.9 mm
Height	8.9 mm
Fastening	tape, pin
Colour	clear
Box size	480 x 280 x 300 mm
Box weight	8.6 kg
Quantity in Box	5544 pcs
ROHS compliant	yes 



MATERIAL SPECIFICATIONS:

Component	Type	Material	Colour
VERONICA-SQ-MINI-RS	Lens	PMMA	clear
VERONICA-SQ-MINI-TAPE	Tape	Acrylic foam	clear

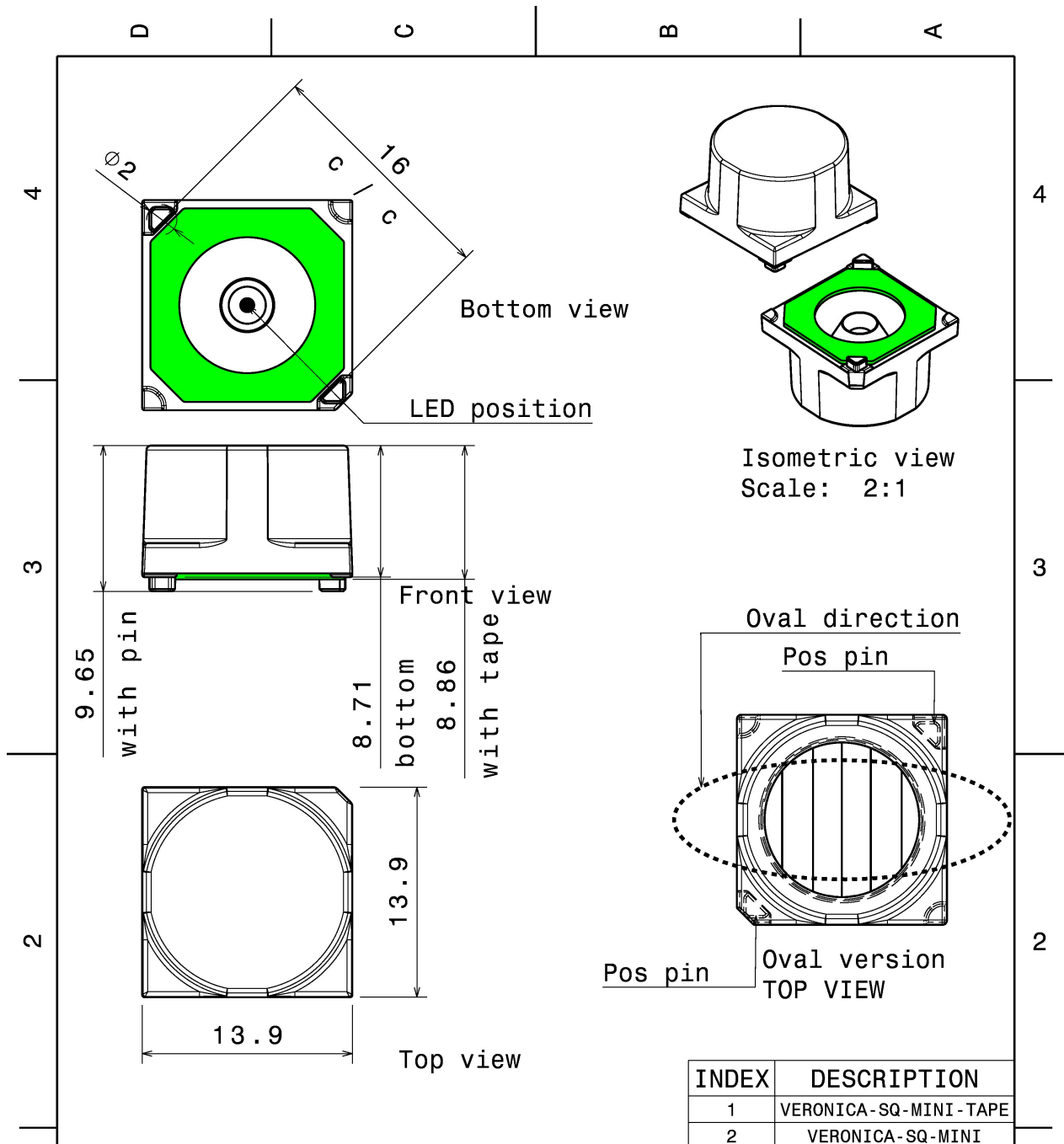

Tolerances if not otherwise shown
According to DIN ISO 2768-1
Linear measures:
up to 30mm class M, otherwise class C
According to DIN ISO 2768-2
Form and position: class L

LEDiL Ledil Oy
Joensuunkatu 13
FIN 24100 SALO
Finland

THIRD ANGLE PROJECTION:

DRAWING TITLE
VERONICA-SQ-MINI

This drawing is the property of LEDiL Oy. It may not be reproduced, copied or communicated without a written agreement with LEDiL Oy.

SIZE	PART NUMBER
A4	-

SCALE	3:1	WEIGHT		SHEET	1/1
-------	-----	--------	--	-------	-----

PHOTOMETRIC DATA (MEASURED):



LED XD16
 FWHM 19.0°
 Efficiency 92 %
 Peak intensity 4.600 cd/lm
 Required components:

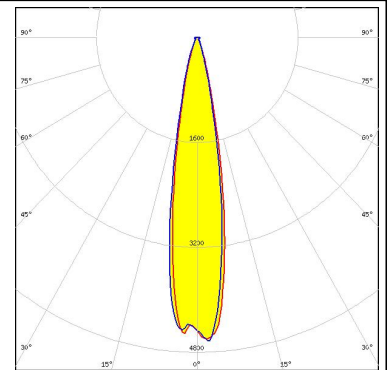

LED XP-E2
 FWHM 14.0°
 Efficiency 92 %
 Peak intensity 11.000 cd/lm
 Required components:

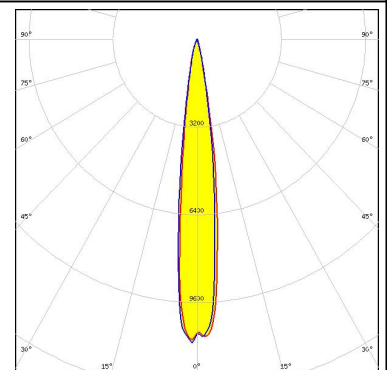

LED XQ-E HI
 FWHM 9.4°
 Efficiency 90 %
 Peak intensity 14.700 cd/lm
 Required components:

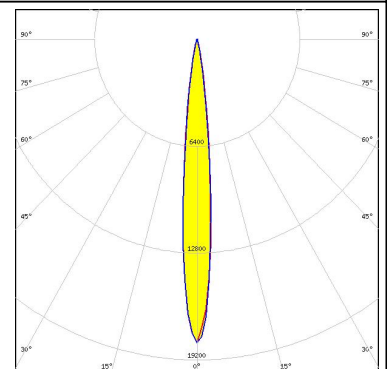
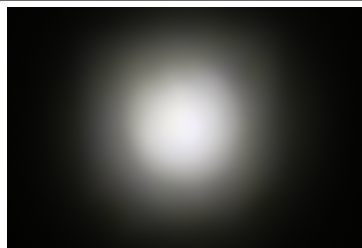

LED LUXEON Rebel ES
 FWHM 21.0°
 Efficiency 83 %
 Peak intensity 4.300 cd/lm
 Required components:

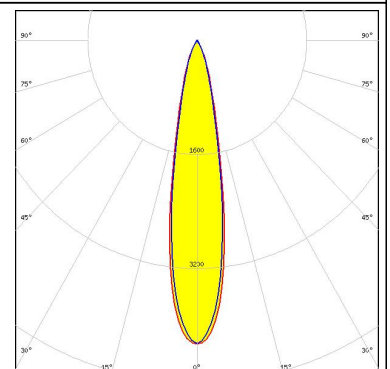
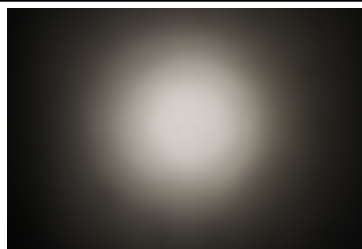

PHOTOMETRIC DATA (MEASURED):



LED LUXEON TX
 FWHM 20.0°
 Efficiency 92 %
 Peak intensity 3.960 cd/lm
 Required components:

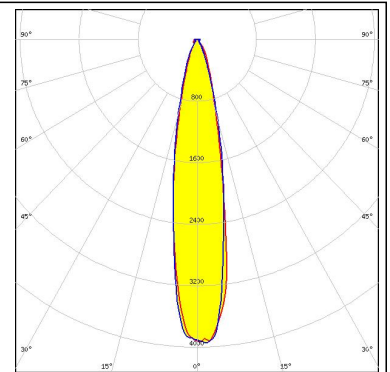
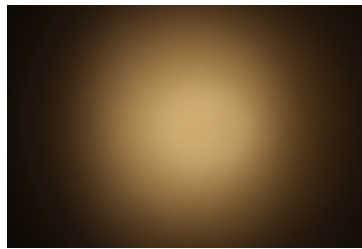

LED NCSxE17A
 FWHM 11.0°
 Efficiency 92 %
 Peak intensity 7.600 cd/lm
 Required components:

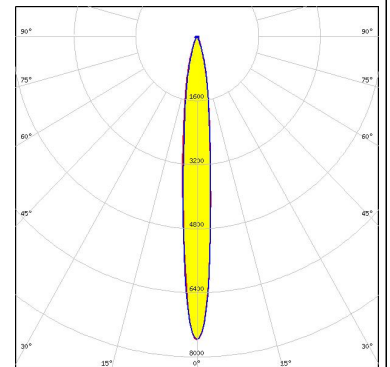

LED NVSxx19B/NVSxx19C
 FWHM 21.0°
 Efficiency 93 %
 Peak intensity 3.800 cd/lm
 Required components:

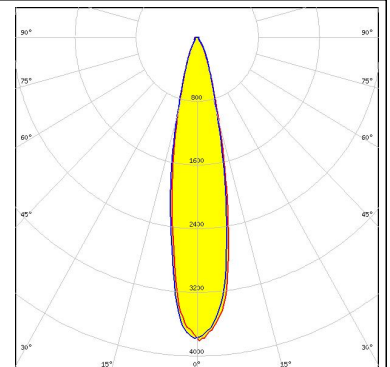

LED Oslon Square EC
 FWHM 18.0°
 Efficiency 91 %
 Peak intensity 5.330 cd/lm
 Required components:

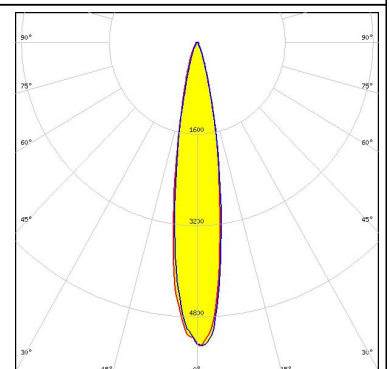
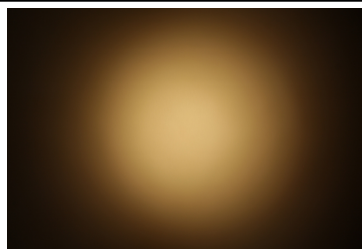

PHOTOMETRIC DATA (MEASURED):

SAMSUNG

LED LH181B
FWHM 22.0°
Efficiency 94 %
Peak intensity 3.500 cd/lm
Required components:

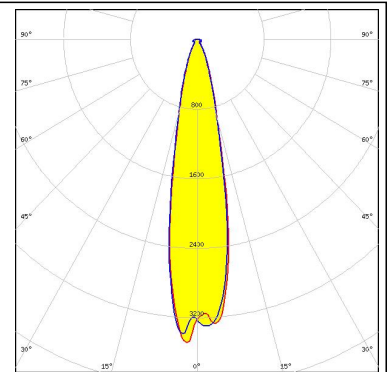

SEOUL SEMICONDUCTOR

LED Z8Y22P
FWHM 21.0°
Efficiency 92 %
Peak intensity 3.000 cd/lm
Required components:

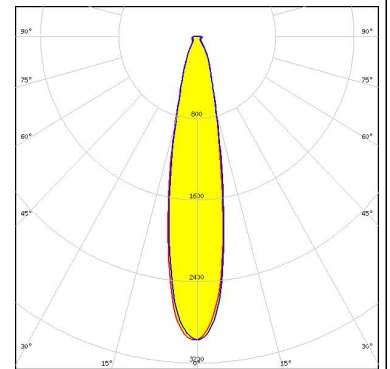
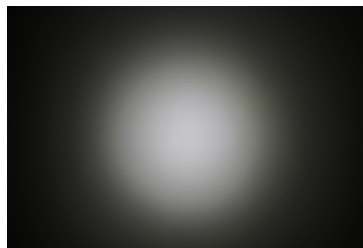

PHOTOMETRIC DATA (SIMULATED):



LED XP-E
 FWHM 15.0°
 Efficiency 92 %
 Peak intensity 10.300 cd/lm
 Required components:

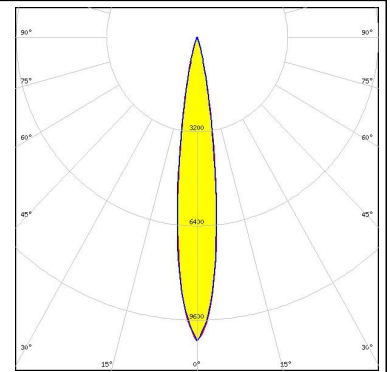

LED XP-G
 FWHM 21.0°
 Efficiency 91 %
 Peak intensity 5.170 cd/lm
 Required components:

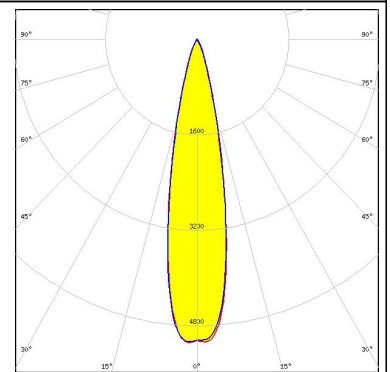

LED XP-G2
 FWHM 20.0°
 Efficiency 93 %
 Peak intensity 6.010 cd/lm
 Required components:

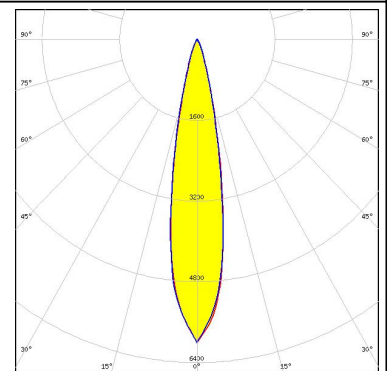

LED XQ-E
 FWHM 13.0°
 Efficiency 89 %
 Peak intensity 11.000 cd/lm
 Required components:

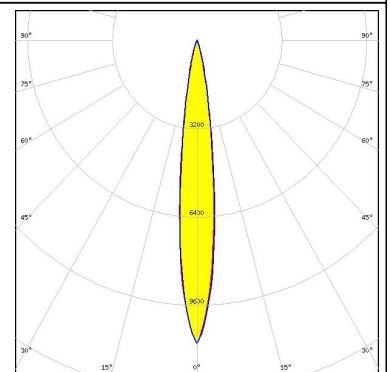

PHOTOMETRIC DATA (SIMULATED):

LG Innotek

LED H35B0 (LEMWA32)
 FWHM 17.0°
 Efficiency 91 %
 Peak intensity 7.270 cd/lm
 Required components:

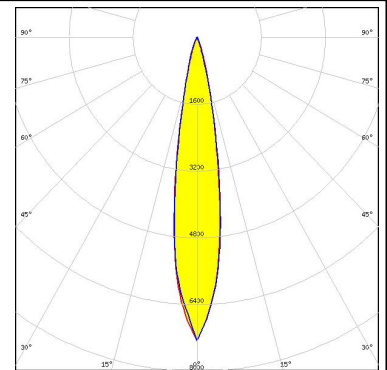

LUMILEDS

LED LUXEON A
 FWHM 21.0°
 Efficiency 89 %
 Peak intensity 4.540 cd/lm
 Required components:

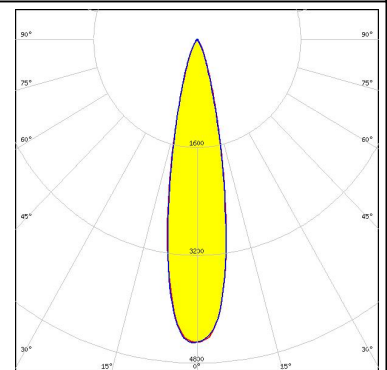

LUMILEDS

LED LUXEON Rebel
 FWHM 16.0°
 Efficiency 87 %
 Peak intensity 7.510 cd/lm
 Required components:

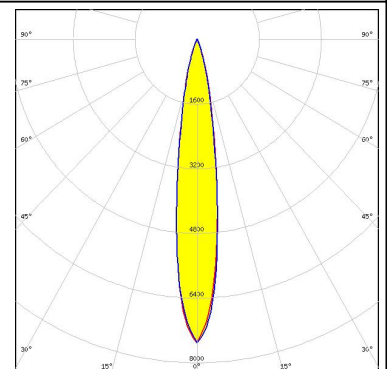

LUMILEDS

LED LUXEON Z ES
 FWHM 14.0°
 Efficiency 89 %
 Peak intensity 9.500 cd/lm
 Required components:

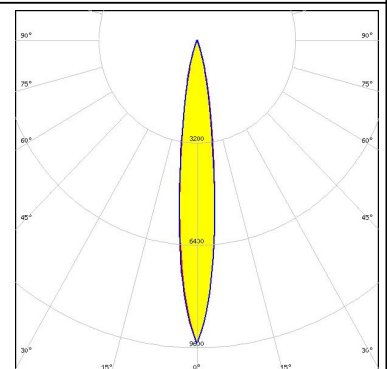

PHOTOMETRIC DATA (SIMULATED):



LED NVSxE21A
 FWHM 15.0°
 Efficiency 94 %
 Peak intensity 5.300 cd/lm
 Required components:

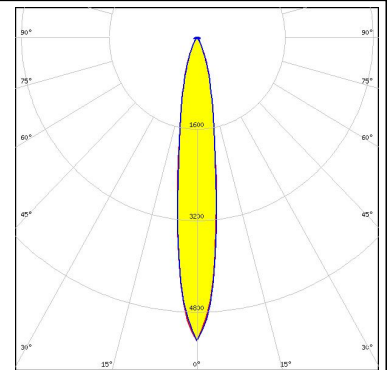

LED Oslon Square Gen3
 FWHM 18.0°
 Efficiency 92 %
 Peak intensity 5.900 cd/lm
 Required components:

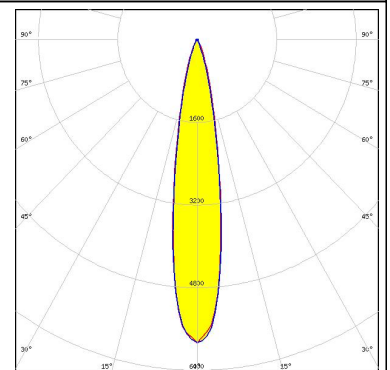

LED Oslon SSL 150
 FWHM 14.0°
 Efficiency 89 %
 Peak intensity 10.700 cd/lm
 Required components:

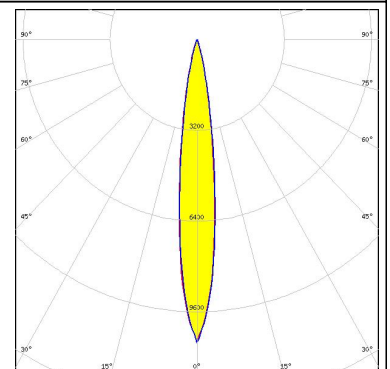

LED Oslon SSL 80
 FWHM 14.0°
 Efficiency 90 %
 Peak intensity 10.200 cd/lm
 Required components:

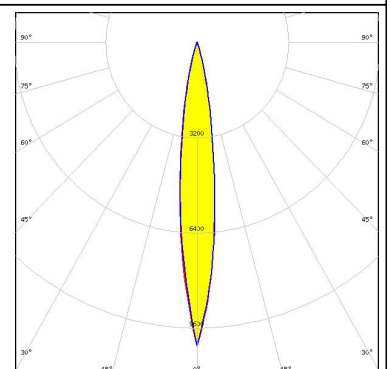

PHOTOMETRIC DATA (SIMULATED):

SAMSUNG

LED LH351Z
FWHM 19.0°
Efficiency 92 %
Peak intensity 6.060 cd/lm
Required components:

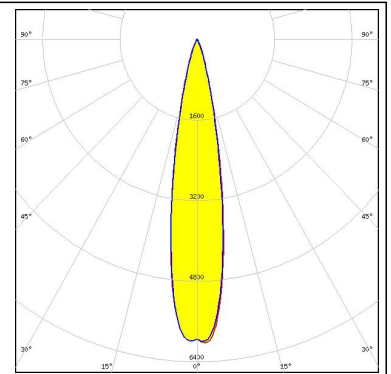

GENERAL INFORMATION:

NOTE: The typical beam angle will be changed by different color, chip size and chip position tolerance. The typical total beam angle is the full angle measured where the luminous intensity is half of the peak value.

MATERIALS:

As part of our continuous research and improvement processes, and to ensure the best possible quality and availability of our products, LEDiL reserves the right to change material grades without notice.

PRODUCT DATA USER AGREEMENT AND DISCLAIMER:

The measured data in the provided downloadable LEDiL Product Datasheets and Mechanical 2D-Drawings is rounded and provided as reference for planning. LEDiL Oy's optical specifications have been verified by conducting performance testing of the products in accordance with the company's quality system. The reported data are averaged results of multiple measurements with typical variation. LEDiL Oy reserves the right to without prior notification make changes and improvements to its products.

LEDiL Oy assumes neither warranty, nor guarantee nor any other liability of any kind for the contents and correctness of the provided data. The provided data has been generated with highest diligence but the provided data may in reality not represent the complete possible variation range of all intrinsic parameters. Therefore, in certain cases a deviation from the provided data could occur.

LEDiL Oy reserves the right to undertake technical changes of its products without further notification which could lead to changes in the provided data. LEDiL Oy assumes no liability of any kind for the possible deviation from any provided data or any other damage resulting from the usage of the provided data.

The user agrees to this disclaimer and user agreement with the download or usage of the provided files.

LEDiL Oy

Joensuunkatu 13
FI-24240 SALO
Finland

LEDiL Inc.

228 West Page Street
Suite D
Sycamore IL 60178
USA

Local sales and technical support

[www.ledil.com/
where_to_buy](http://www.ledil.com/where_to_buy)

Shipping locations

Salo, Finland
Hong Kong, China

Distribution Partners

[www.ledil.com/
where_to_buy](http://www.ledil.com/where_to_buy)